



# B+S BLACK SERIES: GRP-6

## 600mm Grill Plate on Stand

Project: \_\_\_\_\_ Item: \_\_\_\_\_



GRP-6

### Standard Features:

- AISI Grade Stainless Steel
- Heavy duty complete stainless steel frame with undershelf
- 22MJ aluminised tube burner per 300mm section
- Heavy duty mild steel grill plate (16mm Thick)
- Italian made top welded smooth finish design
- Grill Plate cooking area - 595mm W x 550mm D
- Flame Failure - Included as standard
- Piezo ignition to pilot grill plate burner
- Multi-setting gas valve – Allows greater regulation of flame setting
- Easy access to all components for servicing and adjustments
- Easy to clean fat spillage tray

### Options:

- Natural or LPG Gas
- Non-swivel rear castors – Set of two
- Chrome Plating

### Specifications:

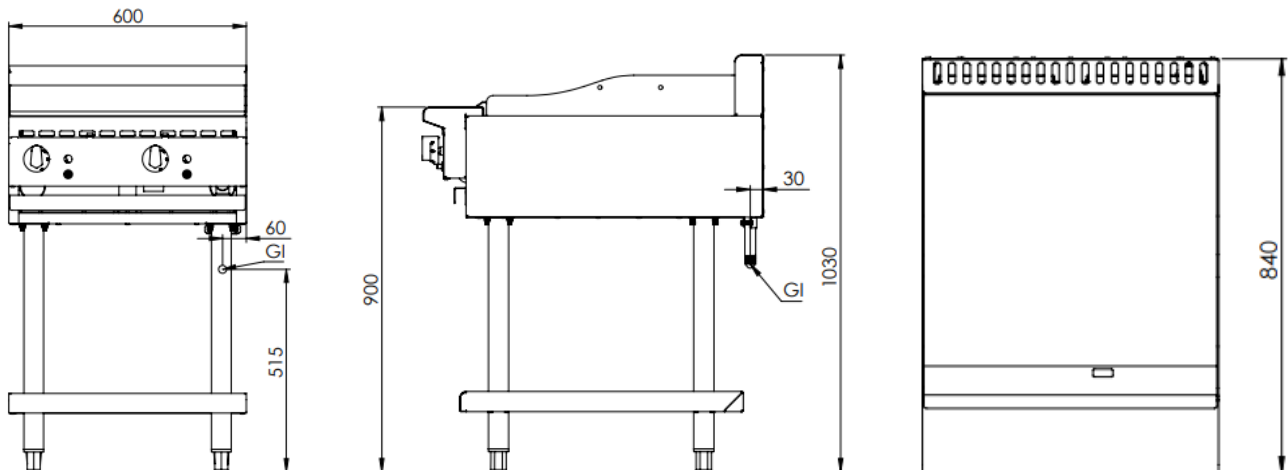

MODEL	LENGTH (mm)	DEPTH (mm)	HEIGHT (mm)	NET WEIGHT (kg)	GAS CONSUMPTION (Mj/h)	
					NG	LPG
GRP-6	600	840	1030	-	44	44

### Connections:

GAS (GI) (BSP)	SUPPLY PRESSURE (kPa)	
	NG	LPG
3/4" (M)	1.0	2.6

- Gas regulator is included with the unit
- **Must** be installed by an authorised installer in accordance to **AS/NZS5601** refer to **current version**

**Due to ongoing Product Development, Product Improvement and Research, B+S Commercial Kitchens reserves the right to alter specification without notice.**

**Approval Number: GMK 10686**



B+S Commercial Kitchens  
57 Plateau Road Reservoir VIC 3073 Australia | +61 3 9469 4754  
info@bscommercialkitchens.com | www.bscommercialkitchens.com

