



K+ SERIES: CSPK-1 Standalone Stock Pot Cooker

Project: _____ Item: _____



CSPK-1

Standard Features:

- AISI Grade Stainless Steel
- Heavy duty mild steel internal frame
- 92MJ 18-Jet Duck Bill Burner (DB)
- Heavy Duty Cast Iron Ring with removable Trivet
- Lever Action Gas Control
- Flame Failure & Pilot - Included as standard
- Easy access to all components for servicing and adjustments
- Easy to clean fat spillage tray

Options:

- Natural or LPG Gas

Specifications:

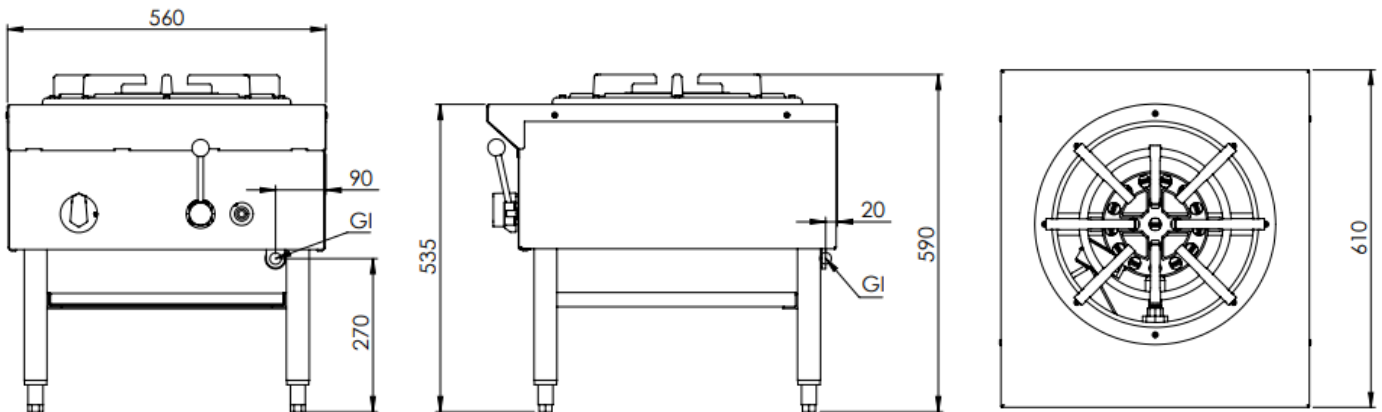

MODEL	LENGTH (mm)	DEPTH (mm)	HEIGHT (mm)	NET WEIGHT (kg)	GAS CONSUMPTION (Mj/h)	
					NG	LPG
CSPK-1	560	610	535 (Hob) 590 (Trivet)	-	92	82

Connections:

GAS (GI) (BSP)	SUPPLY PRESSURE (kPa)	
	NG	LPG
3/4" (F)	1.0	2.6

- Gas regulator is included with the unit
- **Must** be installed by an authorised installer in accordance to **AS/NZS5601** refer to current version

Due to ongoing Product Development, Product Improvement and Research, B+S Commercial Kitchens reserves the right to alter specification without notice.

Approval Number: GMK 10699



B+S Commercial Kitchens
57 Plateau Road Reservoir VIC 3073 Australia | +61 3 9469 4754
info@bscommercialkitchens.com | www.bscommercialkitchens.com

