



B+S BLACK SERIES: IB-900

Infill Bench 900mm

Project: _____ Item: _____



IB-900

Standard Features:

- AISI 304 Grade Stainless Steel
- Heavy duty complete stainless steel frame

Specifications:

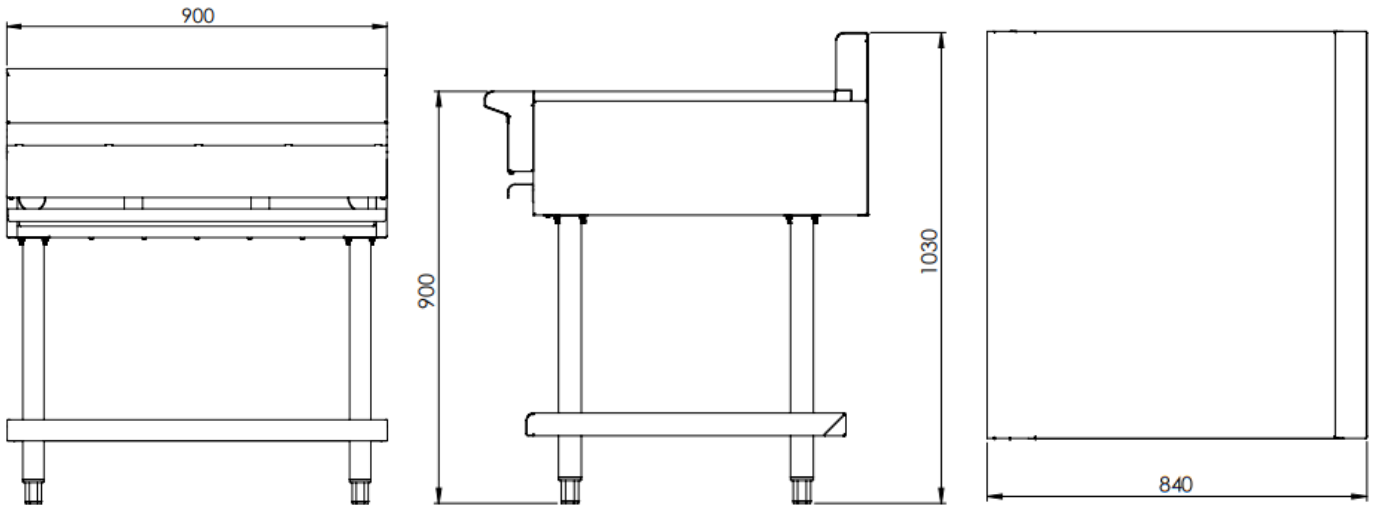

MODEL	LENGTH (mm)	DEPTH (mm)	HEIGHT (mm)
IB-900	900	840	1030

Due to ongoing Product Development, Product Improvement and Research, B+S Commercial Kitchens reserves the right to alter specification without notice.

