



B+S BLACK SERIES: CBR-6

Char Broiler 600mm

Project: _____ Item: _____



CBR-6

Standard Features:

- AISI 304 Grade Stainless Steel
- Heavy duty complete stainless steel frame
- 34MJ stainless steel burner per 300mm section
- Heavy duty cast iron J-Grates & Radiant hoods
- Reversible grates allow for an inclined or flat cooking surface
- Multi-setting gas valve as standard allowing for greater regulation of flame setting
- Easy access to all components for servicing and adjustment
- Easy to clean fat spillage trays
- Flame failure fitted as standard
- 24 Month Warranty

Options:

- Natural or LP Gas
- Non-swivel rear castors

Specifications:

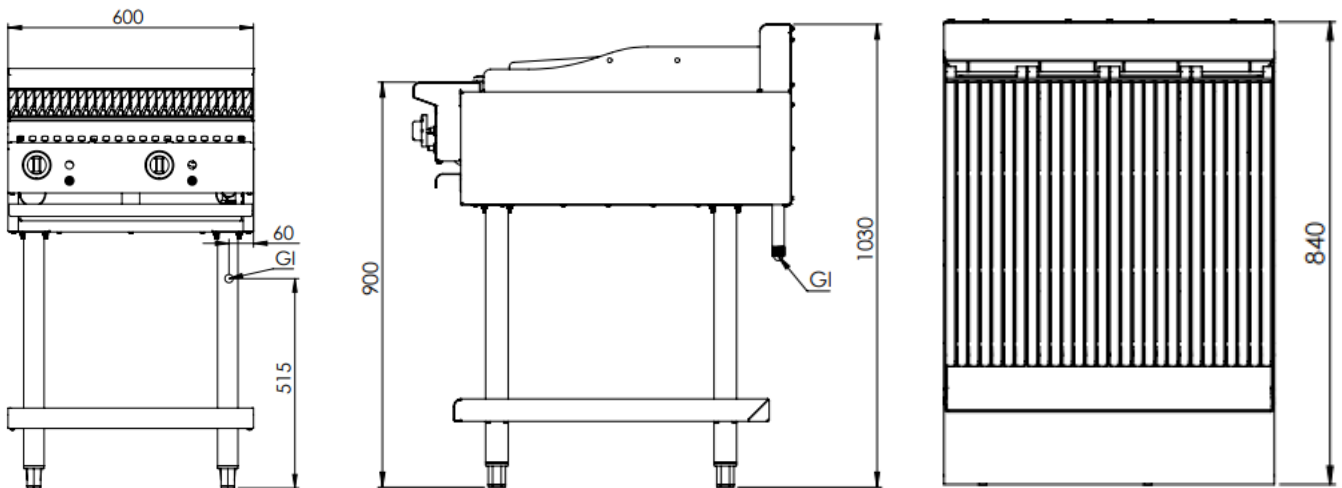

MODEL	LENGTH (mm)	DEPTH (mm)	HEIGHT (mm)	GAS CONSUMPTION (Mj/h)	
				NG	LPG
CBR-6	600	840	1030	68	60

Connections:

GAS (GI) (BSP)	SUPPLY PRESSURE (kPa)	
	NG	LPG
3/4" (M)	1.0	2.6

- Regulator is included in the unit
- **Must** be installed by an authorised installer in accordance to **AS/NZS5601.01**

Due to ongoing Product Development, Product Improvement and Research, B+S Commercial Kitchens reserves the right to alter specification without notice.

Approval Number: GMK 10686



B+S Commercial Kitchens
 57 Plateau Road Reservoir VIC 3073 Australia | +61 3 9469 4754
 info@bscommercialkitchens.com | www.bscommercialkitchens.com

