



K+ SERIES: KGRP-3 Grill Plate 300mm

Project: _____ Item: _____



KGRP-3

Standard Features:

- Stainless Steel Frame
- Heavy Duty Mild Steel Plate (12mm Thick)
- Multi-setting gas valve as standard allowing for greater regulation of flame setting
- Piezo Ignition & Flame Failure Device
- Open Stand with Under Shelf
- Easy to clean fat spillage tray
- Front access to all components makes service easy
- 12-Month Warranty

Options:

- Natural or LP Gas
- Castors

Specifications:

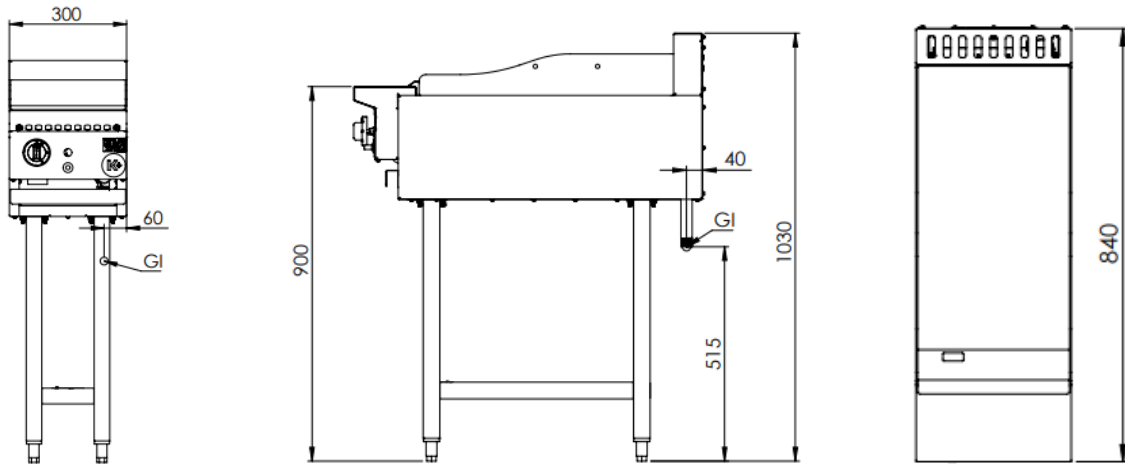

MODEL	LENGTH (mm)	DEPTH (mm)	HEIGHT (mm)	GAS CONSUMPTION (Mj/h)	
				NG	LPG
KGRP-3	300	840	1030	22	22

Connections:

GAS (GI) (BSP)	SUPPLY PRESSURE (kPa)	
	NG	LPG
¾" (M)	1.0	2.6

- Regulator is included in the unit
- **Must** be installed by an authorised installer

Due to ongoing Product Development, Product Improvement and Research, B+S Commercial Kitchens reserves the right to alter specification without notice.



B+S Commercial Kitchens
57 Plateau Road Reservoir VIC 3073 Australia | +61 3 9469 4754
info@bscommercialkitchens.com | www.bscommercialkitchens.com

